

bilz

3D Synchro

Synchro tapping chuck
Tapping and thread forming

M0,5 to M42



RENEWABLE
ENERGIES



GENERAL
MECHANICAL
ENGINEERING



AUTOMOTIVE



ELECTRONICS



OPTICS



FINE MECHANICS



TOOLMAKING

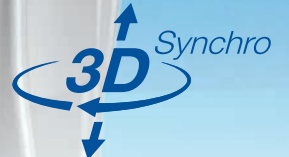

Features

- Minimum length compensation in tension and compression direction
- Ball bearing (i.e. torque-independent) suspension
- Suitable for internal coolant supply up to 80 bar
- Suitable for taps and thread formers
- Suitable for right-hand and left-hand threads
- Optimised spring/damper technology ($\pm 0.5\text{mm}$) 3D Synchro
- Fully encapsulated functional space (washable up to 80°C)
- Optimised seal (comparable to IP68)
- 100% SCK compatible

Tool presetting possible from both sides via axial adjustment screw
(screw is not included in the scope of delivery)

Advantages

- Drastically reduced pressure on machined thread flanks.
- Compensation of synchronisation errors
- Increased process stability
- Extended tool life of the Tap or Former
- Better thread quality

Our Spring-damper technology reduces loads for tapping and thread forming

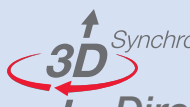
 **3D^{Synchro}**
Direction of rotation
Damping during chip breaking

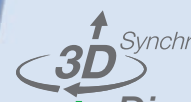
 **3D^{Synchro}**
Direction of pull
Compensate the synchronization errors (Out-feed)

 **3D^{Synchro}**
Compression dampening
Compensates synchronisation errors (In-feed)



Best application



You can use our 3D-Synchro chuck as a collet chuck for driven tool holders as well as for direct clamping in machine spindles.

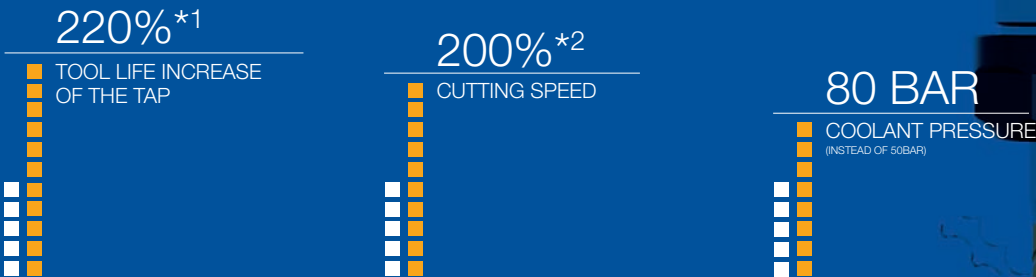

HIGHER PROCESS STABILITY BETTER THREAD QUALITY LONGER SERVICE LIFE

The latest generation S3D- Synchro chuck has been adapted to the current market requirements. Tool presetting is possible from the machine side and the tool side, the lubricant feed-through has been optimized, thus ensuring a leakage-free transfer to the tap.

The length compensation on tension and compression (e.g. +/- 0.5 mm), as well as the damping in the direction of rotation compensate for the smallest synchronization errors and position deviations. This reduces the pressure on the thread flanks of the tool and minimizes the required.

THE TAP LIFE MORE THAN DOUBLED

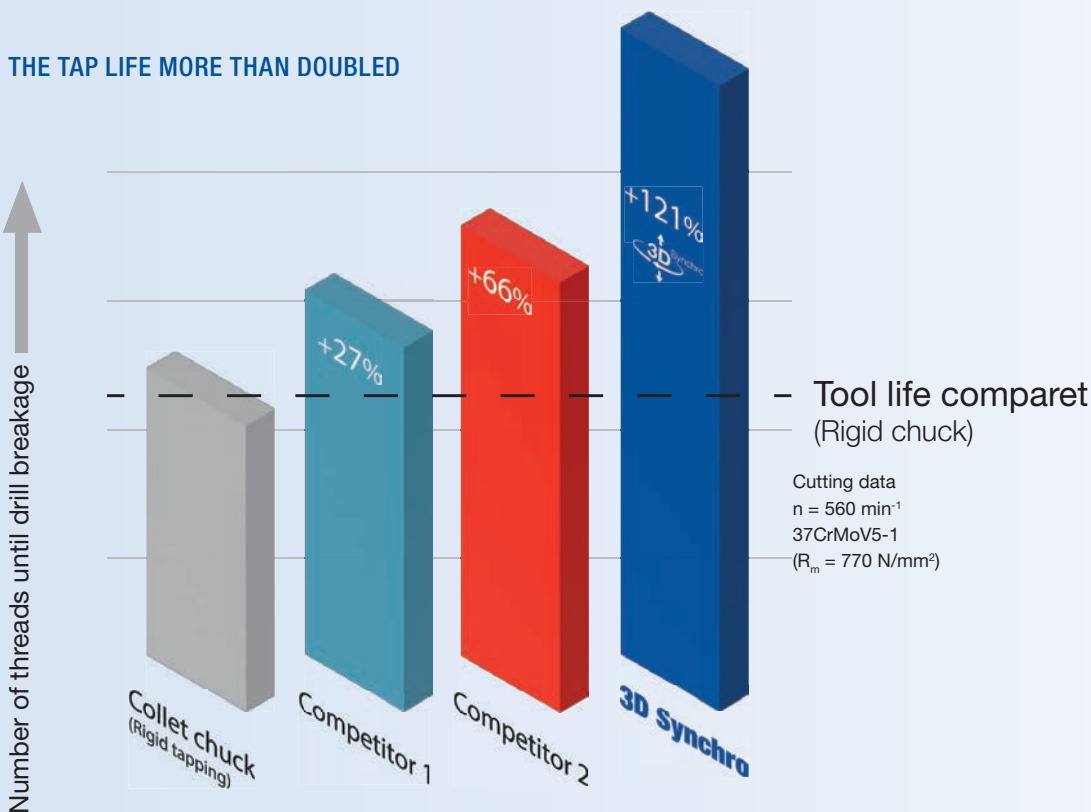

*1 220% tool life of M8 tap in endurance test at n = 560 min⁻¹ in X37CrMoV5-1 (R_m = 770 N/mm²) with the S3D Synchro chuck compared to 100% tool life with a standard collet holder.

*2 200% cutting speed = 25 m/min with M10 tap in grey cast iron GG20 (R_m > 200 N/mm²) with the S3D Synchro chuck compared to 100% = 12.5 25 m/min with a standard collet holder while maintaining thread quality and tolerance. With the standard collet chuck, the cutting speed could not be increased because the thread forms would no longer be in tolerance.

REDUCTION OF THE CUTTING LOAD

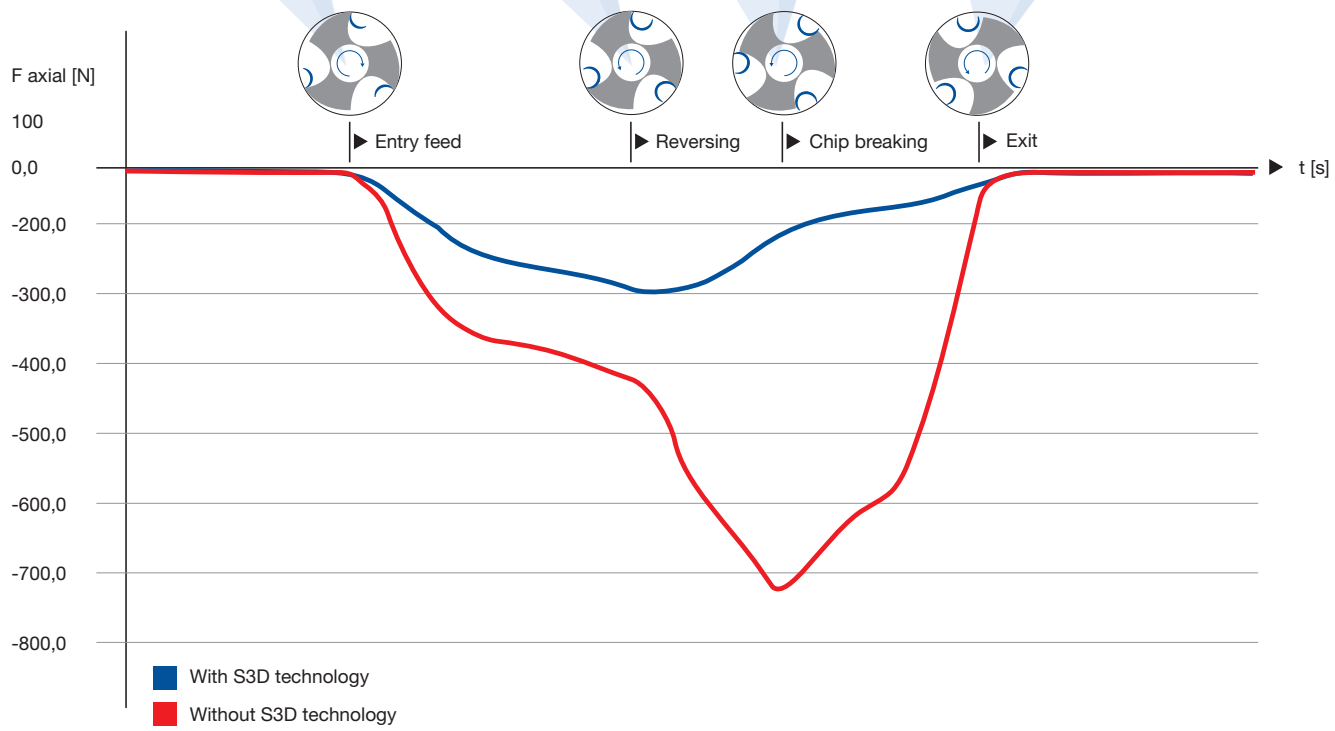

3D Synchro The elastomers used are design stable and resistant to all coolants/lubricants. Due to the defined length compensation, plastic deformation of the damping elements is excluded.

This results in consistent cutting behavior over the entire life of the tool.

Synchro Chuck	Ideal Thread range	Machine interface	Cooling	Features	Page
S3D	M4-M12	HSK-A	IC		6
S3D	M8-M20	HSK-A	IC		7
S3D	M4-M12	Weldon	IC	DIN1835B+E	9
S3D	M8-M20	Weldon	IC	DIN1835B+E	10
S3D	M4-M12	HSK-A	MQL	1-Channel	11
S3D	M8-M20	HSK-A	MQL	1-Channel	12
S3D	M4-M12	HSK-A	MQL	2-Channel	13
S3D	M8-M20	HSK-A	MQL	2-Channel	14
SCK	M14-M30	HSK-A	IC		15
SCK	M30-M42	HSK-A	IC		16
SCK	M14-M30	Weldon	IC	DIN1835B+E	17
SCK	M30-M42	Weldon	IC	DIN1835B+E	18
S3D	M4-M10	HSK-A	IC	Slim design	19
S3D	M4-M10	Weldon	IC	Slim design	20
nano	M0,5-M4,0	Weldon	IC	DIN1835B+E	22
Accessories					21

THREAD RANGES AND CHUCK SIZES

Which areas can we cover?

Synchro Chuck	Ideal Thread range	Clamping Ø	Thread range permissible
S3D0...ER11	M0,5 - M4	Ø 1 - 5	M0,5 - M4
S3D1...ER20	M4 - M12	Ø 4,5 - 12	M4 - M12
S3D2...ER32	M8 - M20	Ø 4,5 - 18	M4 - M20
SCK3...ER40	M14 - M30	Ø 10 - 22	M4 - M30
SCK4...ER50	M30 - M42	Ø 22 - 32	M4 - M42

S3D – Synchro Chuck for M4-M12

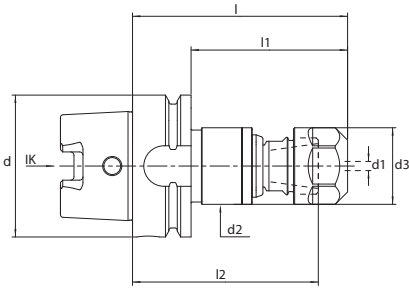

Accessories:

Allen key / length adjustment	
Designation	Id. Nr.
SCK-2,5-90, (l < 104mm)	5012199
SCK-2,5-180, (l > 104mm)	9172118

S3D1-ER20-K1-HSKA									
d1	Designation/Id. Nr.		d	d2	d3	l	l1	l2	
M4-M12	S3D1-ER20-95,5-K1-HSKA63 5181691	+/-0,5	63	34	34	95,5	69,5	82,5	
M4-M12	S3D1-ER20-160-K1-HSKA63 5185749	+/-0,5	63	34	34	160	134	147	
M4-M12	S3D1-ER20-102-K1-HSKA100 5185751	+/-0,5	100	34	34	102	73	89	

Coolant tube, transfer unit and key are not included in the scope of delivery

Coolant pipe / transfer unit	
Designation	Id. Nr.
UE4/HSK63	5025376
UE4/HSK100	5028428

ER/ESX20 – Clamping units

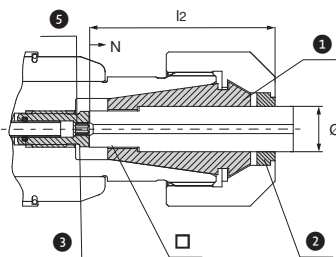

- Collet N = Adjustment
- Sealing disc l2 = Insert depth
- Screw Ø = Shaft diameter
- = Drive square

Mounting key	
Designation	Id. Nr.
HSK63	6738421
HSK100	6738303

ER/ESX..GB auf DIN6499B / ISO15488B / 428E

Clamping unit– ER Version C (consisting of collet, sealing disc, adjusting screw)

Ø x □	Designation/Id. Nr.	S3D.../ ER...	DIN 371	DIN 374 DIN 376	ISO	l2	N	
4,5 x 3,4	SPE4,5x3,4C-ESX20 5013770	ER20/ ESX20	M4	M6		29	3	2,5
5,0 x 4,0	SPE5x4C-ESX20 5013774		M5, M6	M8	M5	30		
6,0 x 4,9	SPE6x4,9C-ESX20 5012479		M7	M9, M10	M6 M8	31		
6,3 x 5,0	SPE6,3x5C-ESX20 5073202		M8	M11	M8 M10	36		
7,0 x 5,5	SPE7x5,5C-ESX20 5208940		M9	M12	M12	37		
7,1 x 5,6	SPE7,1x5,6C-ESX20 5073203		M10	M14	M10	41		
8,0 x 6,2/6,3	SPE8x6,2/6,3C-ESX20 5012481					42		
9,0 x 7,0/7,1	SPE9x7/7,1C-ESX20 5012482							
10,0 x 8,0	SPE10x8C-ESX20 5012483							
11,0 x 9,0	SPE11x9C-ESX20 5013775							
11,2 x 9,0	SPE11,2x9C-ESX20 5035343							
12 x 9,0	SPE12x9C-ESX20 5198365							

S3D – Synchro Chuck for M8-M20

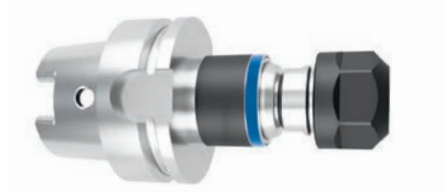
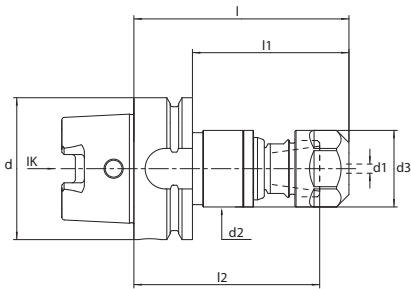

Accessories:

Allen key / length adjustment	
Designation	Id. Nr.
SCK-3-90, (l < 104mm)	5012201
SCK-3-180, (l > 104mm)	9172126

S3D2-ER32-K1-HSKA									
	Designation/Id. Nr.		d	d2	d3	l	l1	l2	d1
M8-M20	S3D2-ER32-109-K1-HSKA63 5190093	+/-0,5	63	50	50	109	83	94,5	
M8-M20	S3D2-ER32-115,5-K1-HSKA100 5190624	+/-0,5	100	50	50	115,5	86,5	101	

Coolant tube, transfer unit and key are not included in the scope of delivery

Coolant pipe / transfer unit	
Designation	Id. Nr.
UE4/HSK63	5025376
UE4/HSK100	5028428

ER/ESX20 – Clamping units

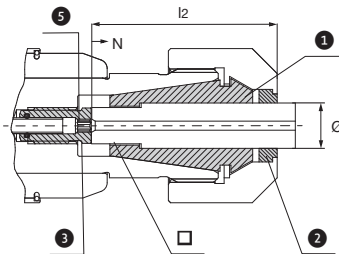

- Collet
 - Sealing disc
 - Screw
 - Drive square
- N = Adjustment
l2 = Insert depth
Ø = Shaft diameter

Mounting key	
Designation	Id. Nr.
HSK63	6738421
HSK100	6738303



ER/ESX...GB auf DIN6499B / ISO15488B / 470E

Clamping unit– ER Version C (consisting of collet, sealing disc, adjusting screw)

	Designation/Id. Nr.	S3D.../ ER...	DIN 371	DIN 374 DIN 376	ISO	l2	N	
6,0 x 4,9	SPE6x4,9C-ESX32 5013821	ER32/ ESX32	M5, M6	M8		31	3	3
6,3 x 5,0	SPE6,3x5C-ESX32 5073204							
7,0 x 5,5	SPE7x5,5C-ESX32 5013822		M7	M9, M10				
7,1 x 5,6	SPE7,1x5,6C-ESX32 5073205					36		
8,0 x 6,2/6,3	SPE8x6,2/6,3C-ESX32 5013823		M8	M11	M8 M10			
9,0 x 7,0/7,1	SPE9x7,7,1C-ESX32 5012485		M9	M12	M12	37		
10,0 x 8,0	SPE10x8C-ESX32 5012486		M10		M10	41		
11,0 x 9,0	SPE11x9C-ESX32 5012487			M14		42		
11,2 x 9,0	SPE11,2x9C-ESX32 5073206				M14			
12,0 x 9,0	SPE12x9C-ESX32 5012488		M12	M16		44		
12,5x10	SPE12,5x10C-ESX32 5035344				M16			
14,0 x 11,0/11,2	SPE14x11/11,2C-ESX32 5012489			M18	M18	45		
16,0 x 12,0/12,5	SPE16x12/12,5C-ESX32 5012490			M20	M22	47		
18,0 x 14,5	SPE18x14,5C-ESX32 5013787			M22, M24				

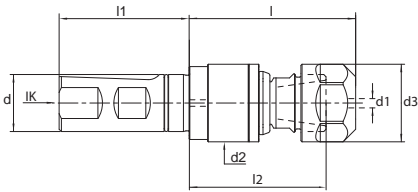
S3D – Synchro Chuck for M4-M12



S3D1-ER20-K1-W DIN1835B+E								
	Designation/Id. Nr.		d	d2	d3	l	l1	l2
d1								
M4-M12	S3D1-ER20-73-K1-W20 5185755	+/-0,5	20	34	34	73		60
M4-M12	S3D1-ER20-73-K1-W25 5181694	+/-0,5	25	34	34	73		60





Accessories:

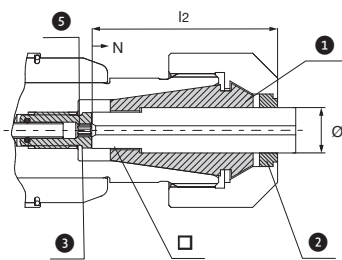

Allen key / length adjustment	
	
Designation	Id. Nr.
SCK-2,5-90, (l < 104mm)	5012199
SCK-2,5-180, (l > 104mm)	9172118

Allen key is not included in delivery

ER/ESX20 – Clamping units



-  Collet N = Adjustment
-  Sealing disc l2 = Insert depth
-  Screw Ø = Shaft diameter
-  □ = Drive square

ER/ESX..GB auf DIN6499B / ISO15488B / 428E								
Clamping unit– ER Version C (consisting of collet, sealing disc, adjusting screw)								
	Designation/Id. Nr.	S3D.../ ER...	DIN 371	DIN 374 DIN 376	ISO	l2	N	
4,5 x 3,4	SPE4,5x3,4C-ESX20 5013770	ER20/ ESX20	M4	M6		29	3	2,5
5,0 x 4,0	SPE5x4C-ESX20 5013774				M5	30		
6,0 x 4,9	SPE6x4,9C-ESX20 5012479		M5, M6	M8		31		
6,3 x 5,0	SPE6,3x5C-ESX20 5073202				M6 M8			
7,0 x 5,5	SPE7x5,5C-ESX20 5208940		M7	M9, M10				
7,1 x 5,6	SPE7,1x5,6C-ESX20 5073203				M9			
8,0 x 6,2/6,3	SPE8x6,2/6,3C-ESX20 5012481		M8	M11	M8 M10	36		
9,0 x 7,0/7,1	SPE9x7,1C-ESX20 5012482		M9	M12	M12	37		
10,0 x 8,0	SPE10x8C-ESX20 5012483		M10		M10	41		
11,0 x 9,0	SPE11x9C-ESX20 5013775				M14	42		
11,2 x 9,0	SPE11,2x9C-ESX20 5035343				M14			
12,0 x 9,0	SPE12x9C-ESX20 5198365		M12					

S3D – Synchro Chuck for M8-M20

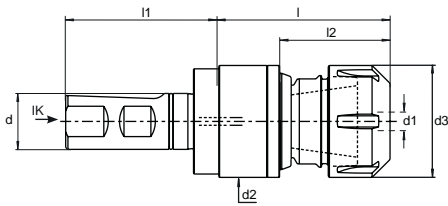

S3D2-ER32-K1-W DIN1835B+E								
d1	Designation/Id. Nr.		d	d2	d3	l	l1	l2
M8-M20	S3D2-ER32-87,5-K1-W25 5190629	+/-0,5	25	50	50	87,5		73

Allen key is not included in delivery

Accessories:

Allen key / length adjustment	
Designation	Id. Nr.
SCK-3-90, (l < 104mm)	5012201
SCK-3-180, (l > 104mm)	9172126

ER/ESX32 – Clamping units

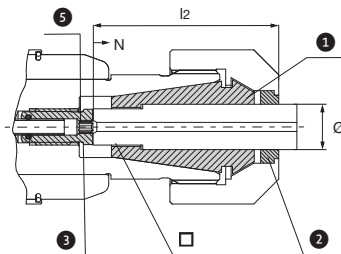



- 1 Collet N = Adjustment
- 2 Sealing disc l2 = Insert depth
- 3 Screw Ø = Shaft diameter
- = Drive square

ER/ESX..GB auf DIN6499B / ISO15488B / 428E									
Clamping unit– ER Version C (consisting of collet, sealing disc, adjusting screw)									
	Designation/Id. Nr. Designation/Id. No.	S3D.../ ER...	DIN 371	DIN 374 DIN 376	ISO	l2	N		
6,0 x 4,9	SPE6x4,9C-ESX32 5013821	ER32/ ESX32	M5, M6	M8		31	3	3	
6,3 x 5,0	SPE6,3x5C-ESX32 5073204								
7,0 x 5,5	SPE7x5,5C-ESX32 5013822		M7	M9, M10					
7,1 x 5,6	SPE7,1x5,6C-ESX32 5073205					36			
8,0 x 6,2/6,3	SPE8x6,2/6,3C-ESX32 5013823		M8	M11	M8 M10				
9,0 x 7,0/7,1	SPE9x7/7,1C-ESX32 5012485		M9	M12	M12	37			
10,0 x 8,0	SPE10x8C-ESX32 5012486		M10		M10	41			
11,0 x 9,0	SPE11x9C-ESX32 5012487			M14		42			
11,2 x 9,0	SPE11,2x9C-ESX32 5073206				M14				
12,0 x 9,0	SPE12x9C-ESX32 5012488		M12	M16		44			
12,5x10	SPE12,5x10C-ESX32 5035344				M16				
14,0 x 11,0/11,2	SPE14x11/11,2C-ESX32 5012489				M18	M18			44
16,0 x 12,0/12,5	SPE16x12/12,5C-ESX32 5012490				M20	M22			45
18,0 x 14,5	SPE18x14,5C-ESX32 5013787				M22, M24				47

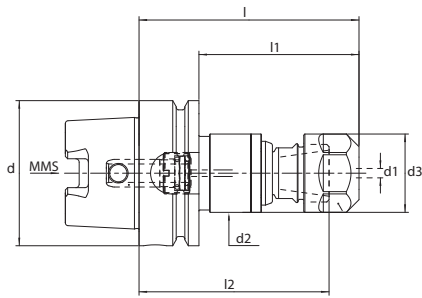
S3D – Synchro Chuck for M4-M12 MQL-1 Channel Version



S3D1-ER20-M1-HSKA									
	Designation/Id. Nr.		d	d2	d3	l	l1	l2	
d1									
M4-M12	S3D1-ER20-95,5-M1-HSKA63 5181692	+/-0,5	63	34	34	95,5	69,5	82,5	
M4-M12	S3D1-ER20-160-M1-HSKA63 5185771	+/-0,5	63	34	34	160	134	147	
M4-M12	S3D1-ER20-102-M1-HSKA100 5194488	+/-0,5	100	34	34	102	73	89	





Accessories:

Allen key / length adjustment	
	
Designation	Id. Nr.
SCK-2,5-90, (l < 104mm)	5012199
SCK-2,5-180, (l > 104mm)	9172118

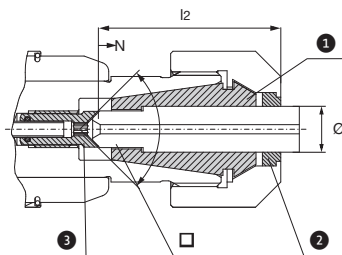
MQL transfer unit included
Allen key is not included in delivery



ER/ESX20 – Clamping units MQL Ausführung



-  Collet N = Adjustment
 -  Sealing disc l2 = Insert depth
 -  Screw Ø = Shaft diameter
-  = Drive square

ER/ESX..GB auf DIN6499B / ISO15488B / 428E

Clamping unit– ER Version B (consisting of collet, sealing disc, adjusting screw)

	Designation/Id. Nr.	S3D.../ ER...	DIN 371	DIN 374 DIN 376	ISO	l2	N	
4,5 x 3,4	SPE4,5x3,4B-ESX20 5047586	ER20/ ESX20	M4	M6		29	2	2,5
5,0 x 4,0	SPE5x4B-ESX20 5047587				M5	30		
6,0 x 4,9	SPE6x4,9B-ESX20 5011485		M5, M6	M8		31	3	
7,0 x 5,5	SPE7x5,5B-ESX20 5011486		M7	M9, M10		31		
8,0 x 6,2/6,3	SPE8x6,2/6,3B-ESX20 5011487		M8	M11	M8, M10	36	3	
9,0 x 7,0/7,1	SPE9x7/7,1B-ESX20 5011488		M9	M12	M12	37		
10,0 x 8,0	SPE10x8B-ESX20 5011489		M10		M10	41		
11,0 x 9,0	SPE11x9B-ESX20 5045461			M14		42		
12,0 x 9,0	SPE12x9B-ESX20 517747		M12					

S3D – Synchro Chuck for M8-M20 MQL-1 Channel Version

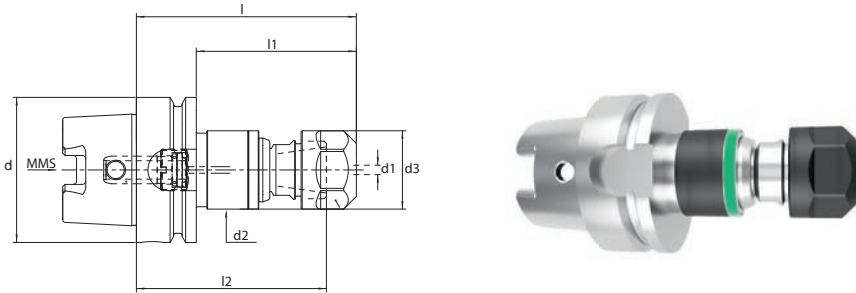

S3D2-ER32-M1-HSKA									
d1	Designation/Id. Nr.			d	d2	d3	l	l1	l2
M8-M20	S3D2-ER32-109-M1-HSKA63 5189297	+/-0,5		63	50	50	109	83	94,5
M8-M20	S3D2-ER32-115,5-M1-HSKA100 5190128	+/-0,5		100	50	50	115,5	86,5	101

Accessories:

Allen key / length adjustment	
Designation	Id. Nr.
SCK-3-90, (l < 104mm)	5012201
SCK-3-180, (l > 104mm)	9172126

MQL transfer unit included
Allen key is not included in delivery

ER/ESX32 – Clamping units MQL Ausführung

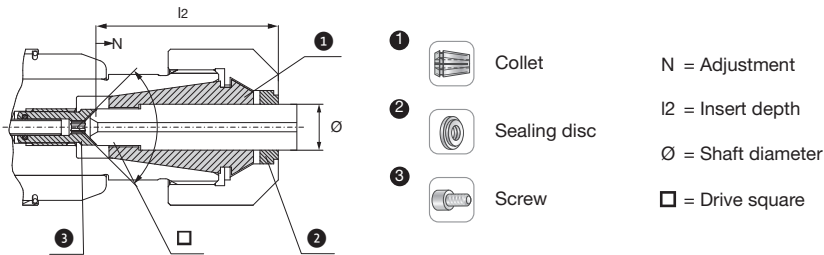

ER/ESX..GB auf DIN6499B / ISO15488B / 470E								
Clamping unit– ER Version B (consisting of collet, sealing disc, adjusting screw)								
	Designation/Id. Nr.	S3D.../ ER...	DIN 371	DIN 374 DIN 376	ISO	l2	N	
9,0 x 7,0/7,1	SPE9x7/7,1B-ESX32 5012108	ER32/ ESX32	M9	M12	M12	37	3	3
10,0 x 8,0	SPE10x8B-ESX32 5012109		M10		M10	41		
11,0 x 9,0	SPE11x9B-ESX32 5012110			M14		42		
12,0 x 9,0	SPE12x9B-ESX32 5012111		M12	M16				
14,0 x 11,0	SPE14x11B-ESX32 5012112			M18	M18	44		
16,0 x 12,0/12,5	SPE16x12,5B-ESX32 5012113			M20	M22	45		

S3D – Synchro Chuck for M4-M12 MQL-2 Channel Version

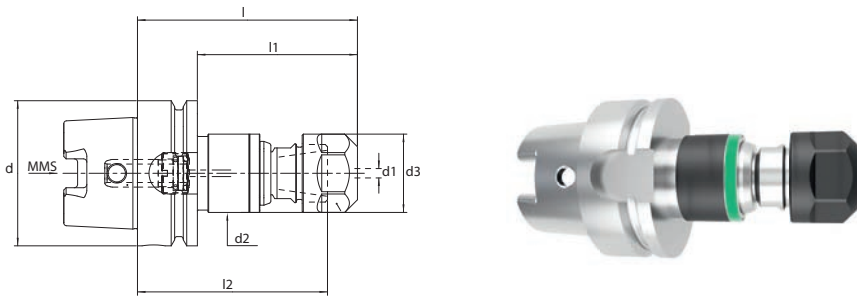

S3D1-ER20-M2-HSKA									
	Designation/Id. Nr.		d	d2	d3	l	l1	l2	
M4-M12	S3D1-ER20-95,5-M2-HSKA63 5181693	+/-0,5	63	34	34	95,5	69,5	82,5	
M4-M12	S3D1-ER20-160-M2-HSKA63 5185773	+/-0,5	63	34	34	160	134	147	
M4-M12	S3D1-ER20-102-M2-HSKA100 5185772	+/-0,5	100	34	34	102	73	89	

Accessories:

Allen key / length adjustment	
Designation	Id. Nr.
SCK-2,5-90, (l < 104mm)	5012199
SCK-2,5-180, (l > 104mm)	9172118

MQL transfer unit included
Allen key is not included in delivery

ER/ESX20 – Clamping units MQL Ausführung

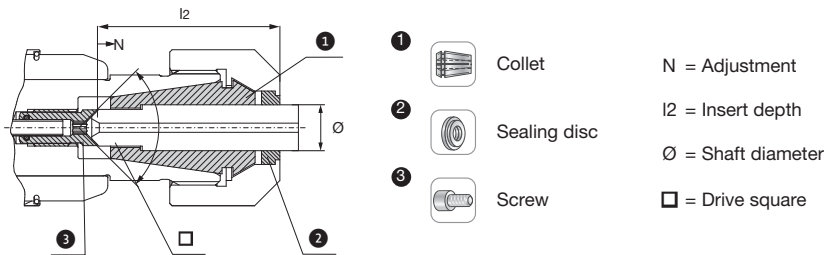

- 1** Collet N = Adjustment
 - 2** Sealing disc l2 = Insert depth
 - 3** Screw Ø = Shaft diameter
- = Drive square

ER/ESX..GB auf DIN6499B / ISO15488B / 428E

Spanneinheit – ER Ausführung B (bestehend aus Collet chuck, Sealing disc, Screw)

	Designation/Id. Nr.	S3D.../ ER...	DIN 371	DIN 374 DIN 376	ISO	l2	N	
4,5 x 3,4	SPE4,5x3,4B-ESX20 5047586	ER20/ ESX20	M4	M6,	M5	29	2	5
5,0 x 4,0	SPE5x4B-ESX20 5047587					30		
6,0 x 4,9	SPE6x4,9B-ESX20 5011485		M5, M6	M8		31	3	
7,0 x 5,5	SPE7x5,5B-ESX20 5011486		M7	M9, M10		31		
8,0 x 6,2/6,3	SPE8x6,2/6,3B-ESX20 5011487		M8	M11	M8, M10	36	3	
9,0 x 7,0/7,1	SPE9x7/7,1B-ESX20 5011488		M9	M12	M12	37		
10,0 x 8,0	SPE10x8B-ESX20 5011489		M10		M10	41		
11,0 x 9,0	SPE11x9B-ESX20 5045461			M14		42		
12x9,0	SPE12x9B-ESX20 517747		M12					

S3D – Synchro Chuck for M8-M20 MQL-2 Channel Version

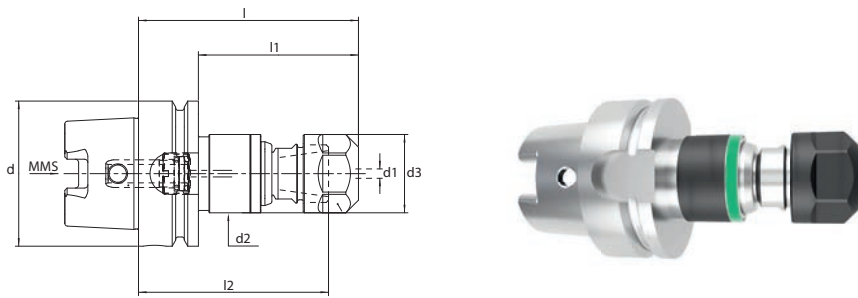

S3D2-ER32-M2-HSKA									
	Designation/Id. Nr.		d	d2	d3	l	l1	l2	
d1									
M8-M20	S3D2-ER32-109-M2-HSKA63 5190631	+/-0,5	63	50	50	109	83	94,5	
M8-M20	S3D2-ER32-115,5-M2-HSKA100 5194491	+/-0,5	100	50	50	115,5	86,5	101	

Accessories:

Allen key / length adjustment	
Designation	Id. Nr.
SCK-3-90, (l < 104mm)	5012201
SCK-3-180, (l > 104mm)	9172126

MQL transfer unit included
Allen key is not included in delivery

ER/ESX32 – Clamping units MQL Ausführung

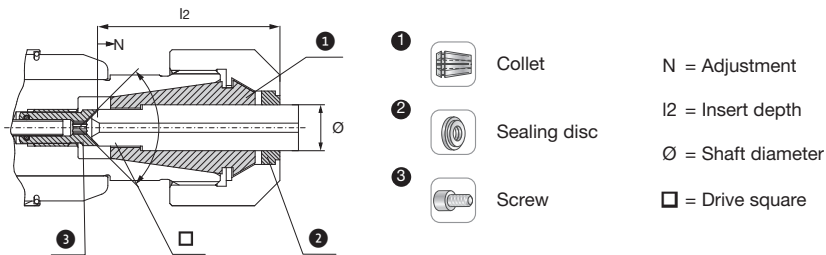

ER/ESX..GB auf DIN6499B / ISO15488B / 470E									
Spanneinheit – ER Ausführung B (bestehend aus Collet chuck, Sealing disc, Screw)									
	Designation/Id. Nr.	S3D.../ ER...	DIN 371	DIN 374 DIN 376	ISO	l2	N		
9,0 x 7,0/7,1	SPE9x7/7,1B-ESX32 5012108	ER32/ ESX32	M9	M12	M12	37	3	3	
10,0 x 8,0	SPE10x8B-ESX32 5012109		M10		M10	41			
11,0 x 9,0	SPE11x9B-ESX32 5012110				M14	42			
12,0 x 9,0	SPE12x9B-ESX32 5012111		M12	M16		44			
14,0 x 11,0	SPE14x11B-ESX32 5012112				M18	M18			44
16,0 x 12,0/12,5	SPE16x12,5B-ESX32 5012113				M20	M22			45

SCK – Synchro Chuck for M14-M30

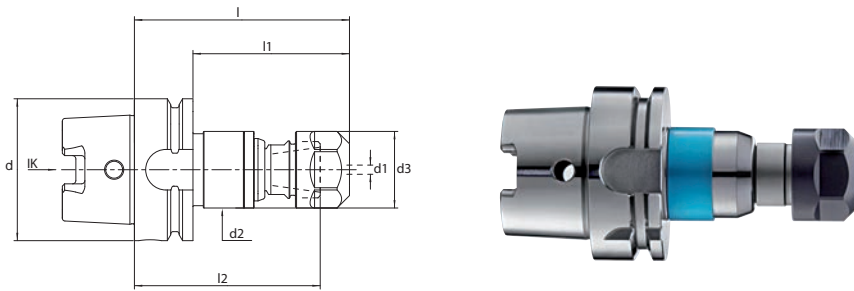

SCK3/HSK-A – ESX40									
	Designation/Id. Nr.			d	d2	d3	l	l1	l2
M14-M30 11 - 22	SCK3-146,5/HSK-A63-ESX40-BL 5017524	+/-0,8		63	63	63	146,5	120,5	50,3
M14-M30 11 - 22	SCK3-136/HSK-A80-ESX40-BL 5040638	+/-0,8		80	63	63	136	110	50,3
M14-M30 11 - 22	SCK3-138/HSK-A100-ESX40-BL 5017526	+/-0,8		100	63	63	138	109	50,3

Coolant tube, coolant transfer unit (CT) and adjustment key included

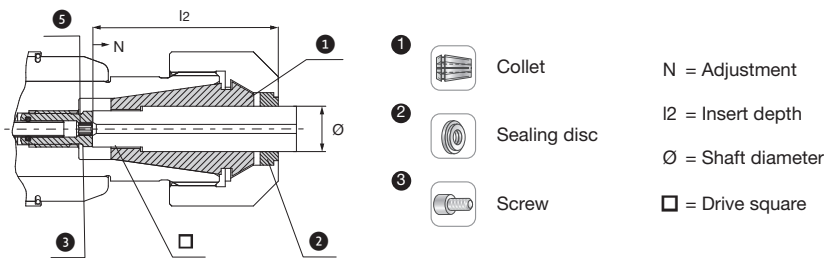

ER/ESX40 – Clamping units IK

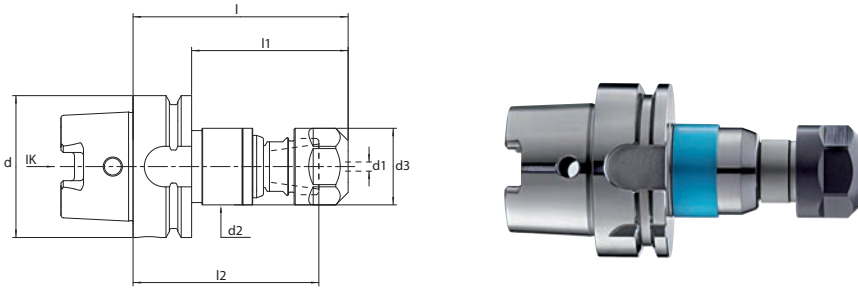

ER/ESX..GB auf DIN6499B /ISO15488B / 472E								
Clamping unit– ER Version C (consisting of collet, sealing disc, adjusting screw)								
	Designation/Id. Nr.	SCK.../ ESX...	DIN 371	DIN 374 DIN 376	ISO	l2	N	
10,0 x 8,0	SPE10x8C-ESX40 5016652	ER40/ ESX40	M10		M10	41	3	3
11,0 x 9,0	SPE11x9C-ESX40 5016653			M14		42		
11,2 x 9	SPE11,2x9C-ESX40 5073207				M14			
12,0 x 9,0	SPE12x9C-ESX40 5016654		M12	M16		44		
14,0 x 11,0/11,2	SPE14x11/11,2C-ESX40 5016655			M18	M20			
16,0 x 12,0/12,5	SPE16x12/12,5C-ESX40 5016656			M20	M22	45		
18,0 x 14,5	SPE18x14,5C-ESX40 5016657			M22		47		
20,0 x 16,0	SPE20x16C-ESX40 5016658			M27	M27 M30	52		
22,0 x 18,0	SPE22x18C-ESX40 5016659			M30		54		

SCK – Synchro Chuck for M30-M42





SCK3/HSK-A – ESX50								
	Designation/Id. Nr.		d	d2	d3	l	l1	l2
M30-M42	SCK4-205/HSK-A100-ESX50-BL	+/-2,0	100	100	78	205	176	66
22 - 32	5085403							

Coolant tube, coolant transfer unit (CT) and adjustment key included

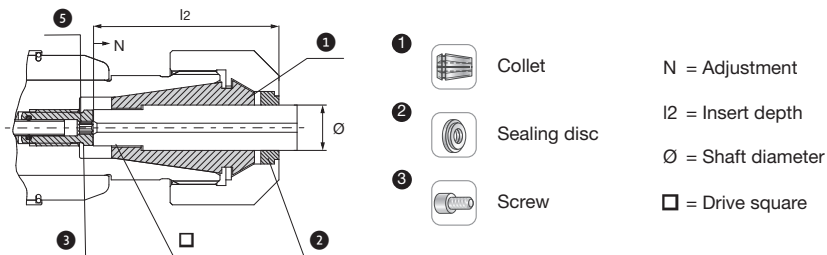
ER/ESX50 – Clamping units IK



ER/ESX..GB auf DIN6499B /ISO15488B / 477E								
Clamping unit– ER Version C (consisting of collet, sealing disc, adjusting screw)								
	Designation/Id. Nr.	SCK.../ ESX...	DIN 371	DIN 374 DIN 376	ISO	l2	N	
22 x 18	SPE22x18C-ESX50	ER50/ ESX50		M30	M36	69	4	6
	5085426							
	SPE25x20C-ESX50							
	5085427							
25 x 20	SPE28x22C-ESX50							
	5085428							
28 x 22	SPE32x24C-ESX50							
	5085429							
32 x 24				M39		75		
				M42				

SCK – Synchro Chuck for M14-M30

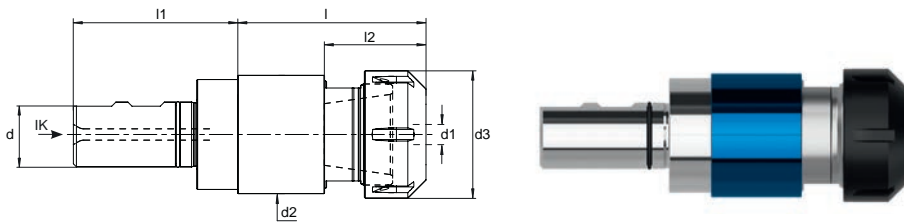

SCK3/W – ESX40 DIN1835B+E									
	Designation/Id. Nr.			d	d2	d3	l	l1	l2
M14-M30	SCK3-113,5//W32-ESX40-BL	+/-0,8		32	63	63	113,5	61	50,3
11 - 22	5017528								

Adjustment key included!

ER/ESX40 – Clamping units IK

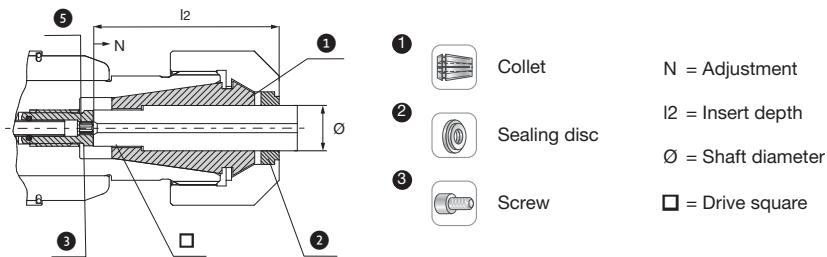



ER/ESX..GB auf DIN6499B /ISO15488B / 472E

Clamping unit– ER Version C (consisting of collet, sealing disc, adjusting screw)

	Designation/Id. Nr.	SCK.../ ESX...	DIN 371	DIN374 DIN 376	ISO	l2	N		
10,0 x 8,0	SPE10x8C-ESX40 5016652	ER40/ ESX40	M10		M10	41	3	6	
11,0 x 9,0	SPE11x9C-ESX40 5016653			M14		42			
11,2 x 9	SPE11,2x9C-ESX40 5073207				M14				
12,0 x 9,0	SPE12x9C-ESX40 5016654		M12	M16		44			
14,0 x 11,0/11,2	SPE14x11/11,2C-ESX40 5016655			M18	M18				
16,0 x 12,0/12,5	SPE16x12/12,5C-ESX40 5016656			M20	M22				45
18,0 x 14,5	SPE18x14,5C-ESX40 5016657			M22					47
20,0 x 16,0	SPE20x16C-ESX40 5016658				M27 M30	52			
22,0 x 18,0	SPE22x18C-ESX40 5016659				M30	54			

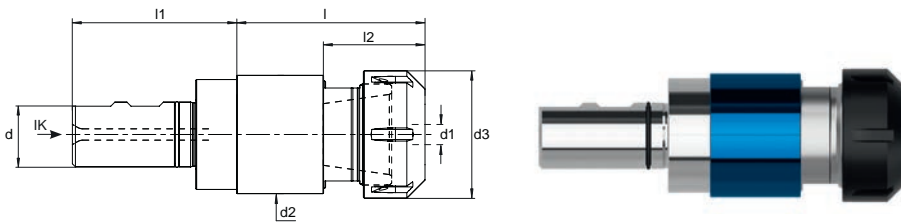
SCK – Synchro Chuck for M30-M42





SCK4/W – ESX50 DIN1835B+E									
	Designation/Id. Nr.		d	d2	d3	l	l1	l2	
M30-M42	SCK4-176/W40-ESX50-BL	+/-2,0	40	100	78	176	71	66	
22 - 32	5085404								

Adjustment key included!

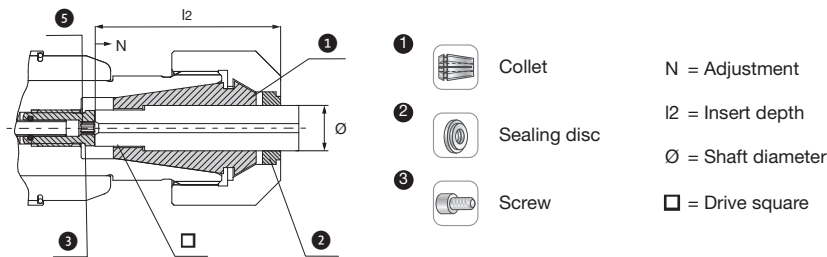
ER/ESX50 – Clamping units IK



ER/ESX..GB auf DIN6499B /ISO15488B / 477E								
Clamping unit– ER Version C (consisting of collet, sealing disc, adjusting screw)								
	Designation/Id. Nr.	SCK.../ ESX...	DIN 371	DIN 374 DIN 376	ISO	l2	N	
22 x 18	SPE22x18C-ESX50 5085426	ER50/ ESX50		M30		69	4	6
25 x 20	SPE25x20C-ESX50 5085427			M33	M36	71		
28 x 22	SPE28x22C-ESX50 5085428			M36		73		
32 x 24	SPE32x24C-ESX50 5085429			M39 M42		75		

3D Synchro

Slim design

Synchro tapping chuck

Tapping and thread forming

M4 to M10

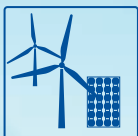
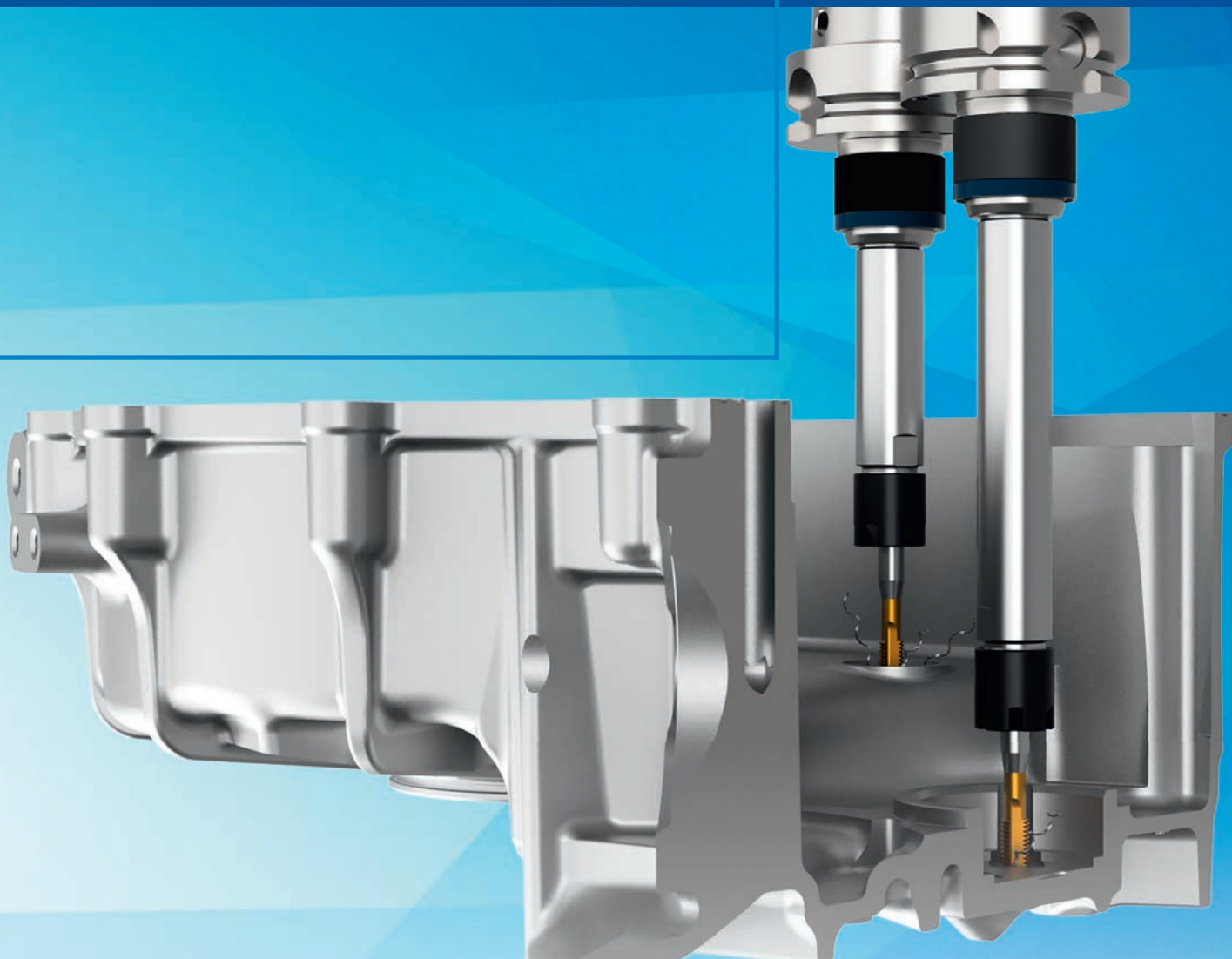

RENEWABLE
ENERGY



GENERAL
MECHANICAL
ENGINEERING



AUTOMOTIVE



ELEKTRONIC



OPTICS



PRECISION
ENGINEERING



TOOLMAKING

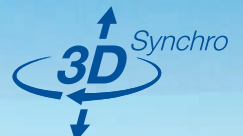

S3D – Synchro Chuck for M4-M10 Slim design

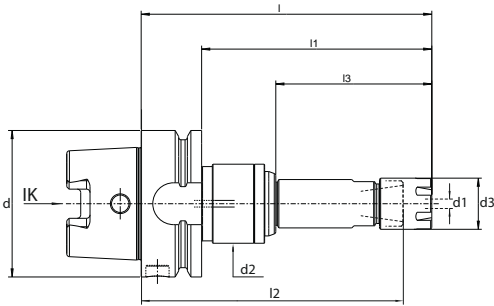

Accessories:

Allen key / length adjustment



Designation	Id. Nr.
SCK-2,5-90, l = (0 - 100mm)	5012201
SCK-2,5-190, l = (101 - 190mm)	9172126
SCK-2,5-320, l = (191 - 330mm)	9173934

Coolant pipe / transfer unit



Designation	Id. Nr.
UE4/HSK63	5025376
UE4/HSK100	5028428

Mounting key



Designation	Id. Nr.
HSK63	6738421
HSK100	6738303

Wrench

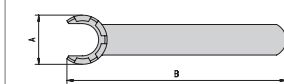

Designation	Id. Nr.
E16M	6932510

S3D1-ER16M-K1-HSKA63										
d1	Designation/Id. Nr.	\pm 0,5	d	d2	d3	l	l1	l2	l3	
M4-M10	S3D1-ER16M-125-K1-HSKA63 5216277	+/- 0,5	63	34	22	125	99	113,5	67,1	
	S3D1-ER16M-150-K1-HSKA63 5216278	+/- 0,5	63	34	22	150	124	138,5	92,1	
	S3D1-ER16M-175-K1-HSKA63 5216279	+/- 0,5	63	34	22	175	149	163,5	117,1	
	S3D1-ER16M-200-K1-HSKA63 5216280	+/- 0,5	63	34	22	200	174	188,5	142,1	
S3D1-ER16M-K1-HSKA100										
M4-M10	S3D1-ER16M-125-K1-HSKA100 5216329	+/- 0,5	63	34		125	99	113,5	60,6	
	S3D1-ER16M-150-K1-HSKA100 5216330	+/- 0,5	63	34	22	150	124	138,5	85,6	
	S3D1-ER16M-175-K1-HSKA100 5216331	+/- 0,5	63	34	22	175	149	163,5	110,6	
	S3D1-ER16M-200-K1-HSKA100 5216332	+/- 0,5	63	34	22	200	174	188,5	135,6	

Coolant tube, transfer unit and key are not included in the scope of delivery

ER/ESX16 – Clamping units

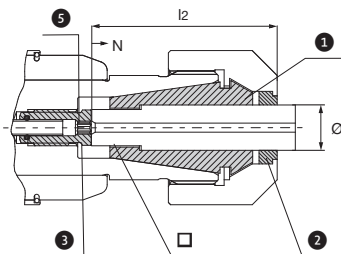

- 1 Collet N = Adjustment
- 2 Sealing disc l2 = Insert depth
- 3 Screw Ø = Shaft diameter
- = Drive square

ER/ESX...GB auf DIN6499B / ISO15488B / 470E

Clamping unit– ER Version C (consisting of collet, sealing disc, adjusting screw)

\emptyset x □	Designation/Id. Nr.	S3D.../ ER...	DIN371	DIN374 DIN376	ISO	l2	N	5
4,5x3,4	SPE4,5x3,4C-ESX16 5046280	ER16/ ESX16	M4	M6	M5	29	2	2
5,0x4,0	SPE5x4C-ESX16 5046279		M5, M6	M8		30	3	
6,0x4,9	SPE6x4,9C-ESX16 5046276				M7	M9, M10		31
7,0x5,5	SPE7x5,5C-ESX16 5046275		M8	M11	M8, M10	36		
8,0x6,2	SPE8x6,2C-ESX16 5046274		M9	M12*	M12*	37		
9,0x7,0	SPE9x7C-ESX16 5033588							

* For easy processing

S3D – Synchro Chuck for M4-M10 Slim design

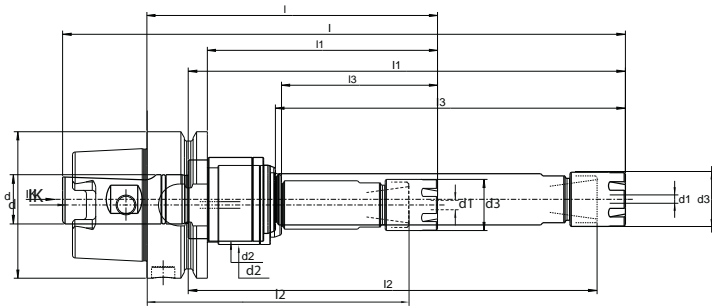

S3D1-ER16M-K1-W20 - DIN1835 Form B und E										
d1	Designation/Id. Nr.		d	d2	d3	l	l1	l2	l3	
M4-M10	S3D1-ER16M-102,5-K1-W20 5222040	+/- 0,5	20	34	22	153,5	102,5	91	67,1	
	S3D1-ER16M-127,5-K1-W20 5222041	+/- 0,5	20	34	22	178,5	127,5	116	92,1	
	S3D1-ER16M-152,5-K1-W20 5222042	+/- 0,5	20	34	22	203,5	152,5	141	117,1	
	S3D1-ER16M-177,5-K1-W20 5222043	+/- 0,5	20	34	22	228,5	177,5	166	142,1	

Accessories:

Allen key / length adjustment	
Designation	Id. Nr.
SCK-2,5-90, l = (0 - 100mm)	5012201
SCK-2,5-190, l = (101 - 190mm)	9172126
SCK-2,5-320, l = (191 - 330mm)	9173934

Wrench	
Designation	Id. Nr.
E16M	6932510

ER/ESX16 – Clamping units

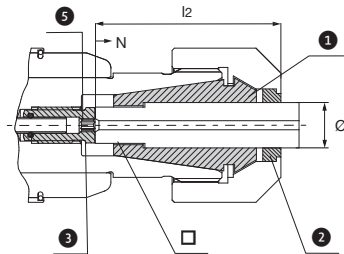

- 1 Collet N = Adjustment
- 2 Sealing disc l2 = Insert depth
- 3 Screw Ø = Shaft diameter
- 4 Drive square

ER/ESX..GB auf DIN6499B / ISO15488B / 470E									
Clamping unit– ER Version C (consisting of collet, sealing disc, adjusting screw)									
Ø x □	Designation/Id. Nr.	S3D.../ ER...	DIN 371	DIN 374 DIN 376	ISO	l2	N	5	
4,5x3,4	SPE4,5x3,4C-ESX16 5046280	ER16/ ESX16	M4	M6		29	2	2	
5,0x4,0	SPE5x4C-ESX16 5046279				M5	30	3		
6,0x4,9	SPE6x4,9C-ESX16 5046276		M5, M6	M8		31			
7,0x5,5	SPE7x5,5C-ESX16 5046275		M7	M9, M10		31			
8,0x6,2	SPE8x6,2C-ESX16 5046274		M8	M11	M8, M10	36			
9,0x7,0	SPE9x7C-ESX16 5033588		M9	M12*	M12*	37			
									2,5

* For easy processing

Variant	Designation Id. Nr.		A	B	C	L1		L2	SW
						Collet chuck			
						with Drive square	without Drive square		
S3D1 ER16*	EX16-IC 6931372		28	22,5	M22x1,5	12	12,0–15,5	5	25
S3D1 ER20	EX20-IC 6931227		34	24	M25x1,5	13	13,0–16,5	5	30
S3D2 ER25	EX25-IC 6941678		42	25	M32x1,5	13,5	13,5–17,0	5	
S3D2 ER32	EX32-IC 6933897		50	27,5	M40x1,5	14,5	14,5–18,0	5	
SCK3 ESX40	EX40-IC 6948425		63	30,5	M50x1,5	16,5	16,5–20,0	5	
SCK4 ESX50	EX50-IC 5085410		78	40,3	M64x2	19	19,0–26,0	7	

* Not compatible with S3D...ER16M...

Torque wrench TORCO-FIX				
	Designation	Id.Nr.	L1	Torque Nm
	TORCO-FIX I	6734177	335	10 – 50
	TORCO-FIX II	6734178	465	40 – 200
	TORCO-FIX III	6734179	565	60 – 300

Variant	Assembly keys TORCO-FIX					
		Designation	Nr	TORCO-Fix	a	b
ER11		A-E11P	5047900	I	32	61
ER16		A-E16P	6953670	I, II	44	71
ER20		A-E20P	5003125	II	52	81
ER25		A-E25	6953671	II	70	72
ER32		A-E32	6952304	II, III	80	72
ESX40		A-E40	5000742	II, III	96	82
ESX50		A-E50	5003124	III	111	94
ER11M		A-E 11M	5047901	I	16,8	54,4
ER16M		A-E 16M	5047902	I, II	22,5	56,2
ER20M		A-E20M	5047903	I, II	29	68,2
ER25M		A-E25M	5076778	I, II	36	70,0



Mounting fixture			
Designation/Id. Nr.	h mm	l mm	b mm
S3D0-SCK3 5195314	220	108	200
Compatible with S3D... ER11M, ...ER16M, ...ER20, ... ER32 und SCK...ESX40			

Nano Synchro

Synchro tapping chuck
Tapping and thread forming

M0,5 to M4

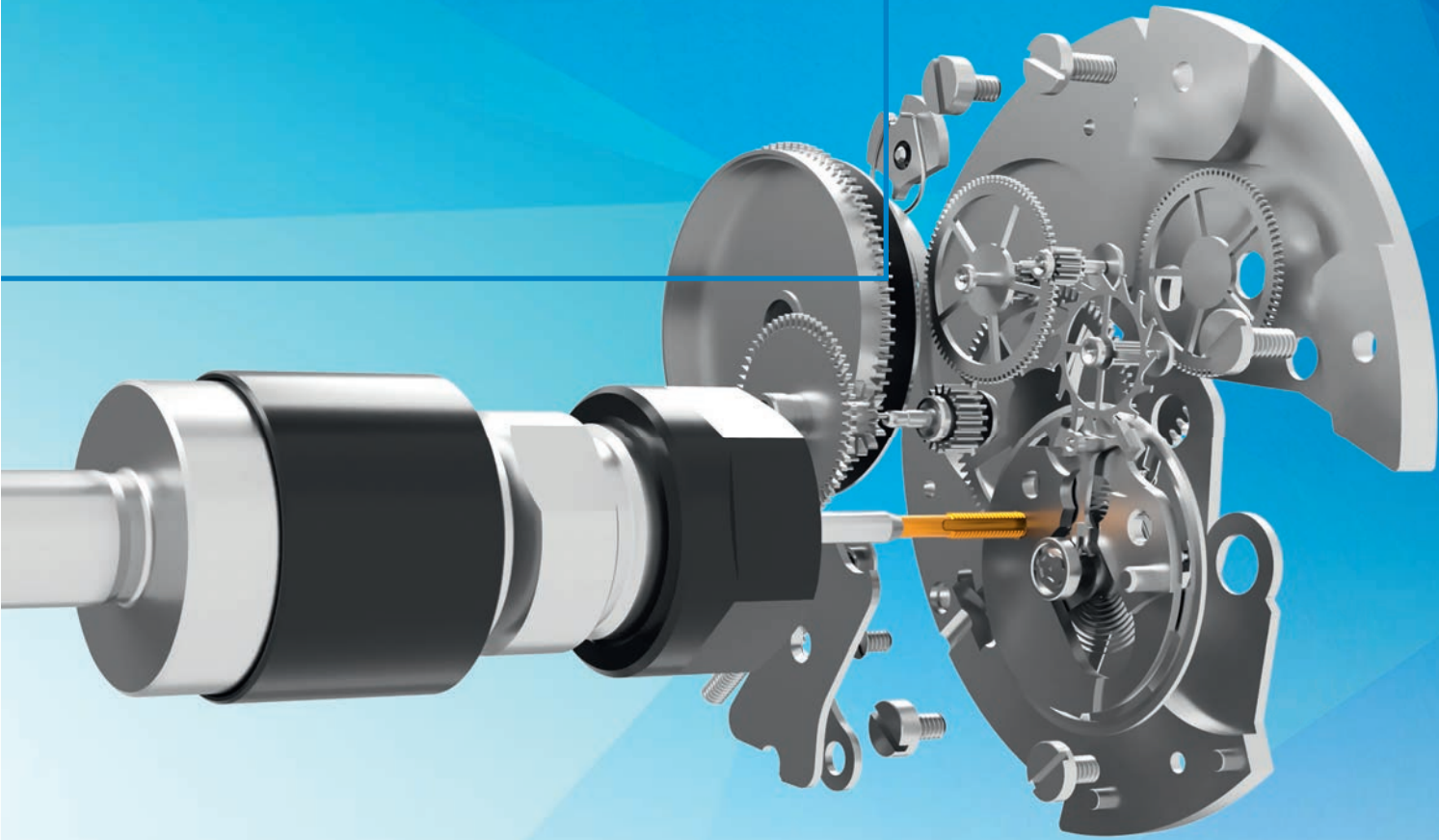

ELECTRONIC



VISUAL OPTICS



PRECISION
ENGINEERING



TOOLMAKING



Features

- Minimum tension and compression compensation
- Ball bearing technology, (application without turning moment) dampening
- Suitable for cutting and forming taps
- Suitable for right and lefthand threads
- Optimised spring and dampening compensation (+/- 0.5mm)
- Suitable for internal coolant supply up to 50 bar



Advantages

- Highest process stability
- Extended tapping tool-life
- Improved thread quality
- Reduction of thread flank cutting-pressures
- Compensates spindle synchronisation errors.

TECHNOLOGY IN HIGHEST PRECISION FOR LIGHTEST APPLICATIONS

Highest technology precision for your applications.



Ball bearing technology, (application without turning moment) dampening

Thread cutting and forming
M0.5 to M4

Optimised spring and dampening compensation (+/- 0.5mm)

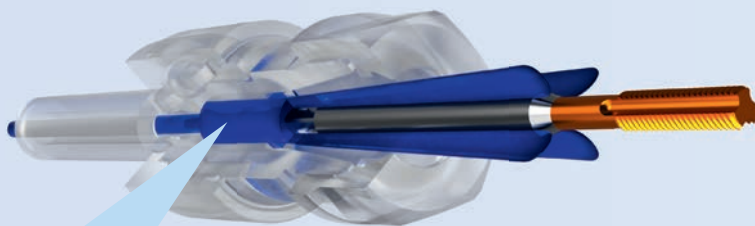

Internal coolant supply (max 50 bar) for optimum supply of lubricant through the collet chuck slots directly to the cutting edge of the Tapping.

Thermogrip®
Shrink Chucks
Catalogue



CNC
Catalogue



Flexible applications

Our Nano Synchro tapping chuck can be applied as a collet chuck for driven aggregates, does not need to be clamped directly in the machine spindle.

186%*

LEVEL QUANTITY OF THE THREAD FORMER



* Up to 186% tool life of the M1 Thread former, determined in the endurance test with n=1000 min-1 in X5CrNi 18-10 with the Nano Synchro chuck compared to 100% of a standard collet chuck.

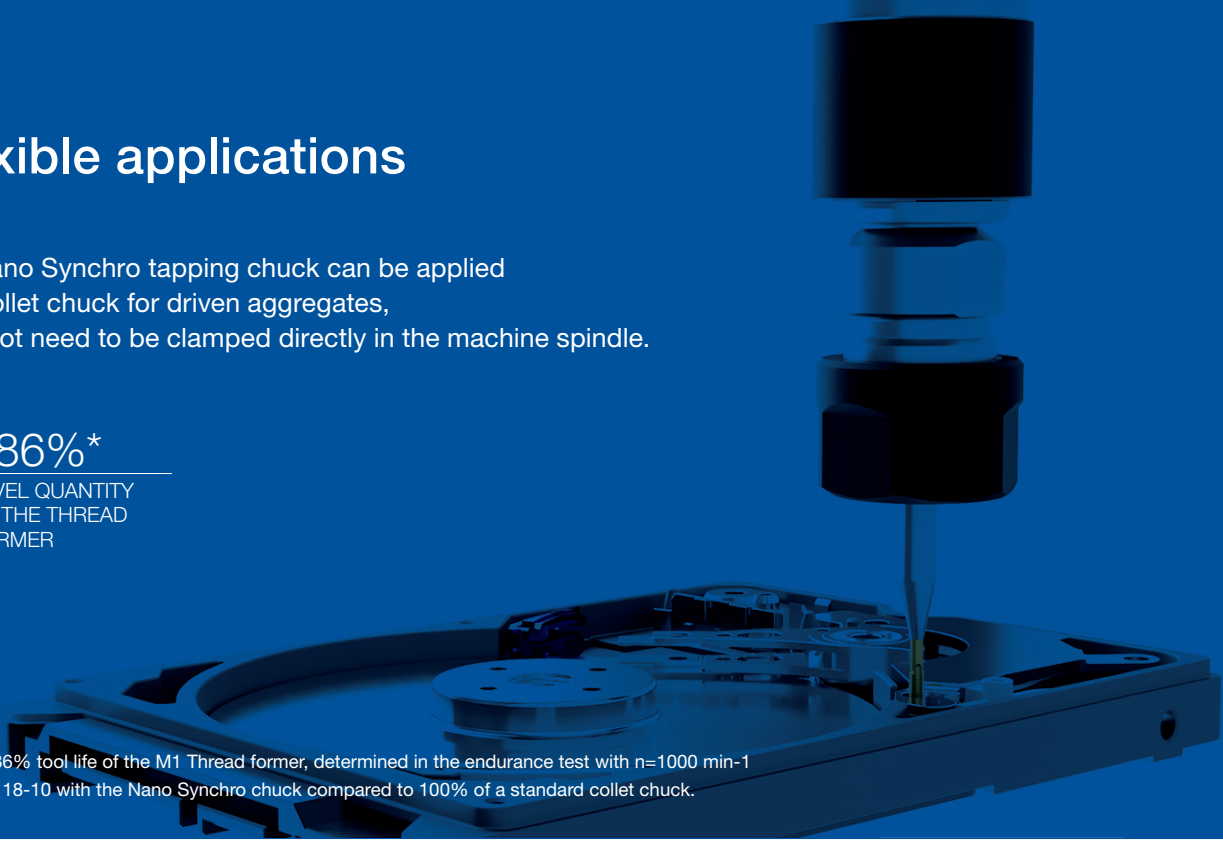

MECHANICAL CLAMPING, SHRINKING OR SELF LOCKING

Many possibilities to use our Nano Synchro chuck in your current process strategy.

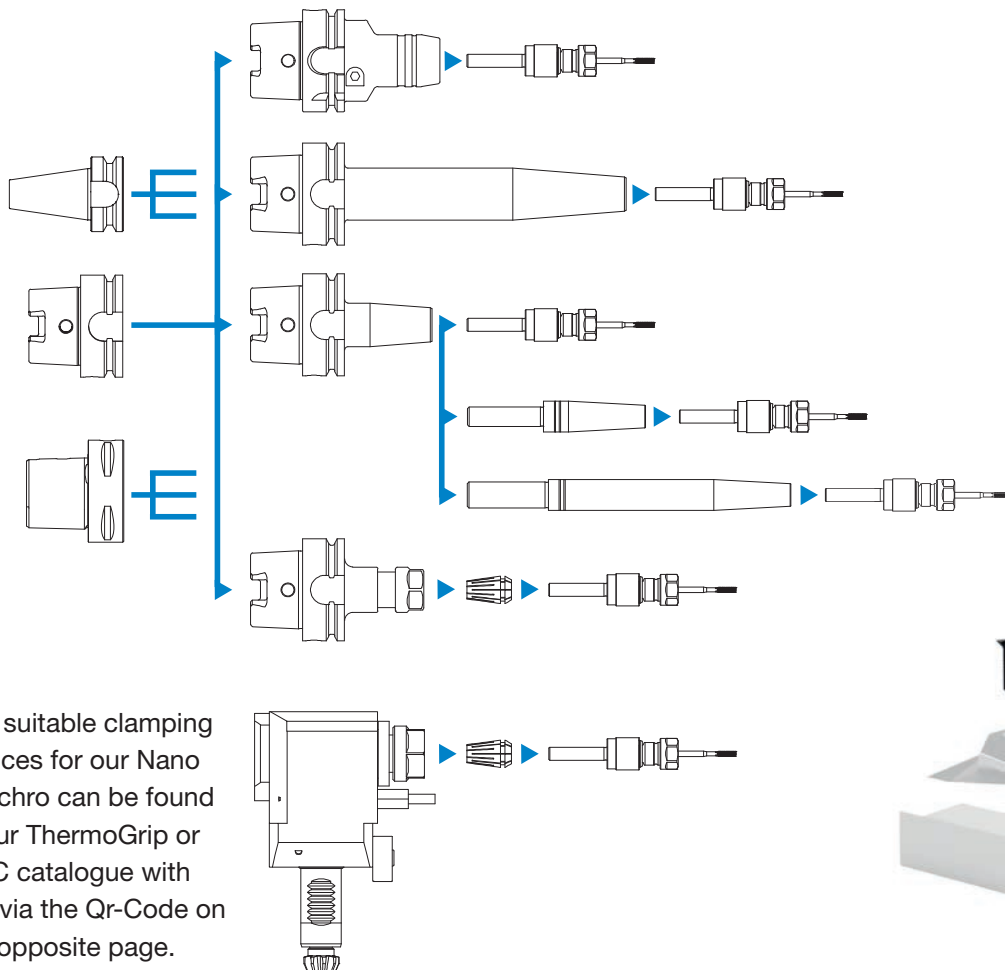

The suitable clamping devices for our Nano Synchro can be found in our ThermoGrip or CNC catalogue with link via the Qr-Code on the opposite page.

Nano Synchro

Tapping and thread forming M0.5 to M4

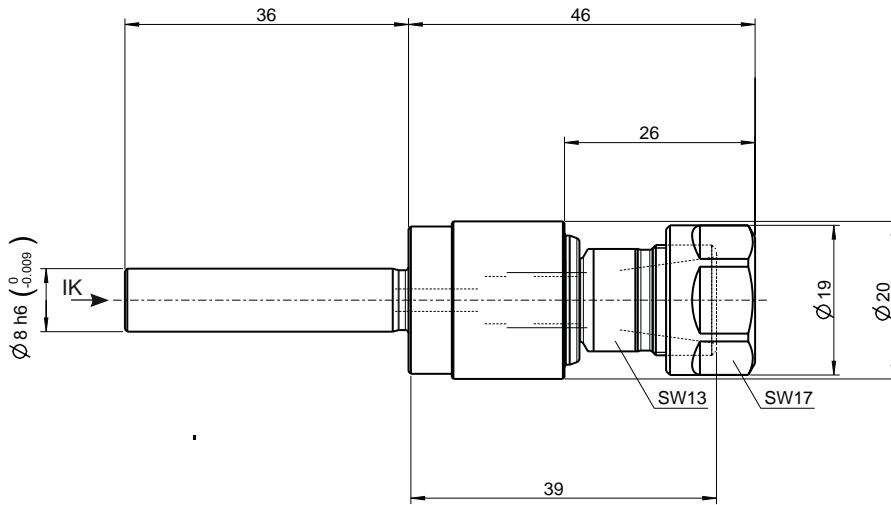

Nano Synchro			
	Description	Ident Nr.	
M0,5 - M4	S3D0-ER11-44-K1-Z0800	5216345	+/-0,5

Accessories:

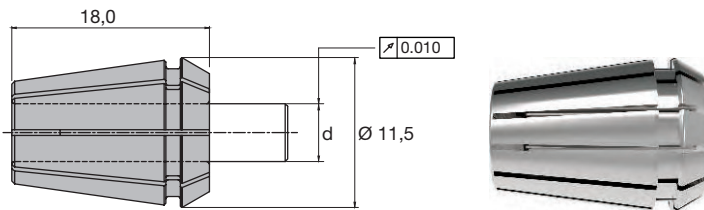

Tap				Collets DIN 6499 System ER 11	
		JIS	Shank \varnothing (mm)	Clamping range d (mm)	Ident Nr.
DIN 371	DIN 376				
				$\varnothing 1.0 - \varnothing 0.5$	5056179
	M1,6-M1,8		$\varnothing 1,2$	$\varnothing 2.0 - \varnothing 1.0$	5056181
	M2		$\varnothing 1,4$		
	M2,2-M2,3		$\varnothing 1,6$		
	M2,5-M2,6		$\varnothing 1,8$	$\varnothing 3.0 - \varnothing 2.0$	5056182
M1-M1,8	M3,5		$\varnothing 2,5 \times \square 2,1$		
M2-M2,6	M4		$\varnothing 2,8 \times \square 2,1$		
		M1-M2,6	$\varnothing 3,0 \times \square 2,5$	$\varnothing 4.0 - \varnothing 3.0$	5056184
M3			$\varnothing 3,5 \times \square 2,7$		
M3,5			$\varnothing 4,0 \times \square 3,0$		
		M3	$\varnothing 4,0 \times \square 3,2$	$\varnothing 5.0 - \varnothing 4.0$	5056187
M4			$\varnothing 4,5 \times \square 3,4$		
		M4	$\varnothing 5,0 \times \square 4,0$		